

12

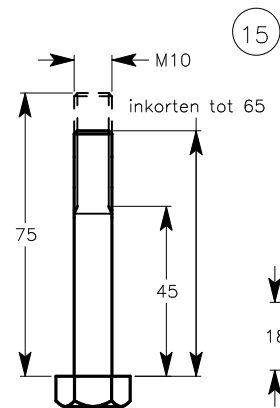

15

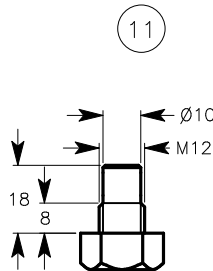

11

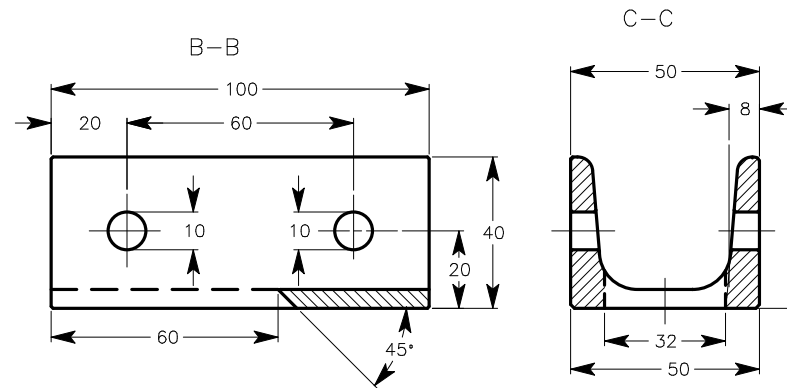
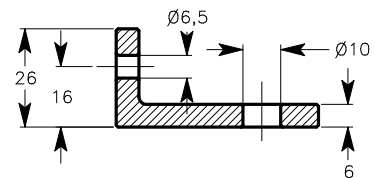

10

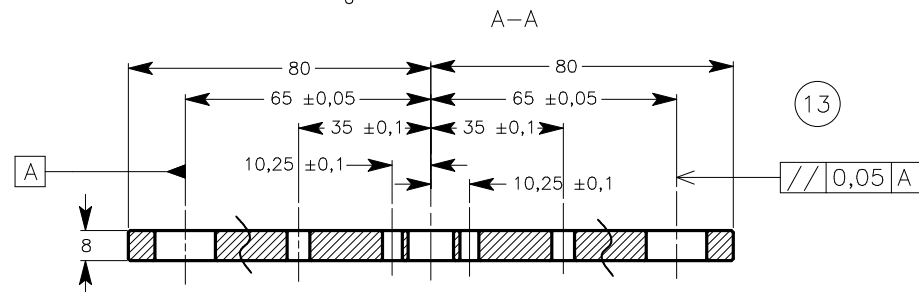
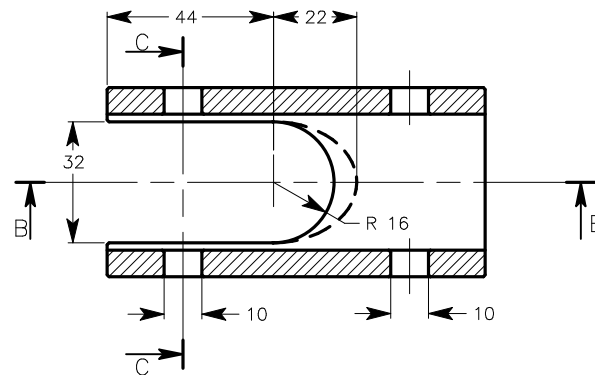

13

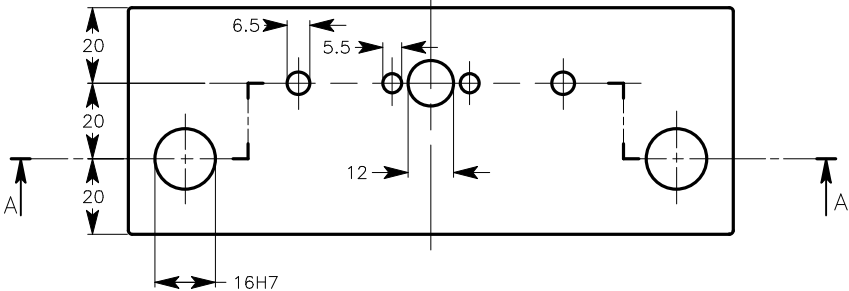

19

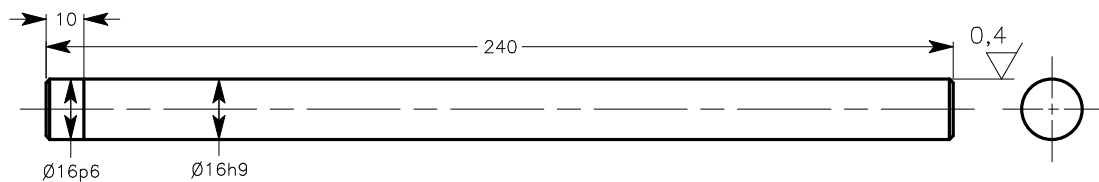

alle toleranties 0,5mm, tenzij anders aangegeven  
alle gaten 0,1mm tolerantie, tenzij anders aangegeven

19	2	GELEIDER STANG	Assenstaal	Ø16*240	
15	2	BOUT + 2 MOER		M10*65	bewerkt
13	1	STEUNPLAAT	Sheet Fe37	160*60*8	
12	2	HOEKSTUK	Hoekijzer Fe37	53,5*26*6	40 lang
11	2	BOUT		M12*18	bewerkt
10	1	HANDEL BALKJE	Balkstaal Fe37	50*40*100	
Part nr.	Num ber	Part name	Material or semi manufacture	Dimension in mm	Remarks
Titel: <b>HANDEL MECHANI.</b>			Drawn by: <b>F. Alferink</b>	Date: <b>08-11-2000</b>	
			Checked by: <b>S.G. Honhoff</b>		
			Part of: <b>SP-V3/1</b>		
			Drawing nr: <b>SP-V3/1/03</b>		
			<b>Werkgroep OntwikkelingsTechnieken</b>		<b>A4</b>
			<i>Universiteit Twente</i>		