

Northern Power Systems, Inc.
Waitsfield, Vermont USA

Hybrid Power for Village Applications

Examples of Medium-Sized Systems:

Joanes, Brazil
Lime Village, Alaska
St. Paul Island, Alaska

Presented At Village Power '98
World Bank, Washington, DC

Northern
Power
Systems

Northern Power Systems

- Manufacturer of renewable & hybrid power systems since 1975
- Telecom & village installations in over 30 countries & on all 7 continents
- Integrated power systems engineered for specific applications or sites
- Northern Power components include:
 - ◇ Hybrid System Controllers
 - ◇ Monitoring Systems
 - ◇ Wind Turbines
 - ◇ Controlled Environment Shelters
 - ◇ Photovoltaic Array Frames & Trackers
 - ◇ Rotary DC/AC Power Converters

Hybrid Village Power System Joanes, Brazil

<u>Type of System</u>	50 kW; grid interconnect; wind/PV, battery storage
<u>Application</u>	Support of a weak diesel grid to deliver energy and stabilize power quality during hours of peak demand
<u>Location</u>	Island of Marajo in the Amazon/Tocantins delta
<u>Population</u>	2000
<u>Peak Loads</u>	>75 kW
<u>Funding</u>	NREL; CEPEL (Brazilian renewable energy organization); CELPA (Utility of the state of Para)
<u>Project Status</u>	Commissioned in 1997; being operated by CELPA; satellite link provides access to data

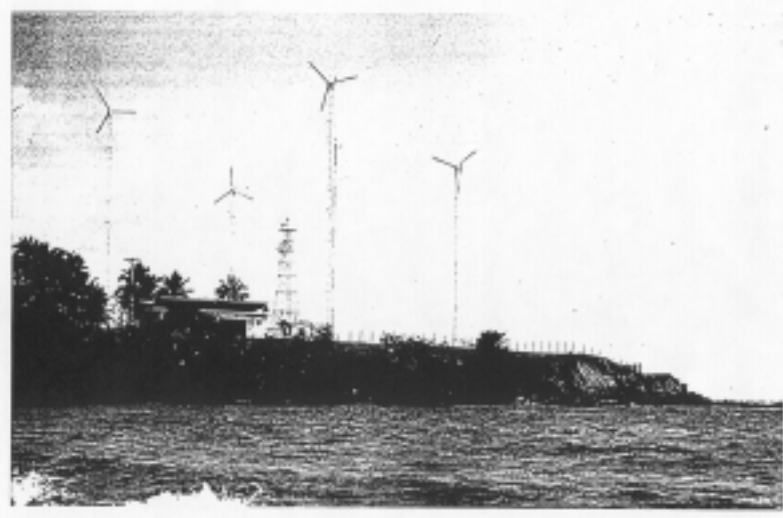

Configuration

NPS Controller/Monitor
Utility Interconnect Switchgear
228 kWh Battery Bank

4 Bergey Excel-R Wind Turbines
10 kW Photovoltaic Array
NPS 50 kW DC/AC Rotary Converter
w/o Engine

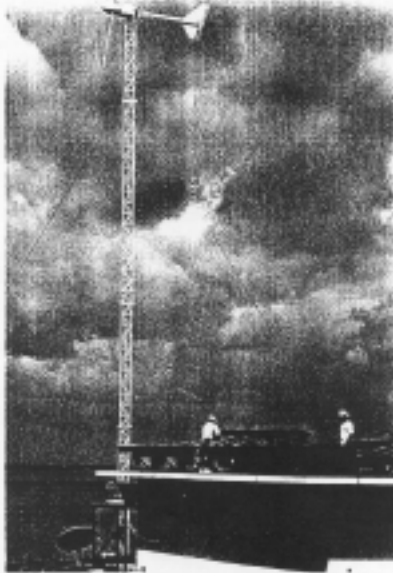
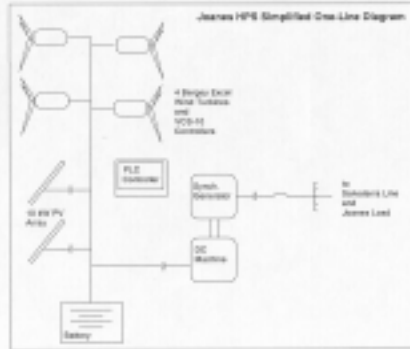

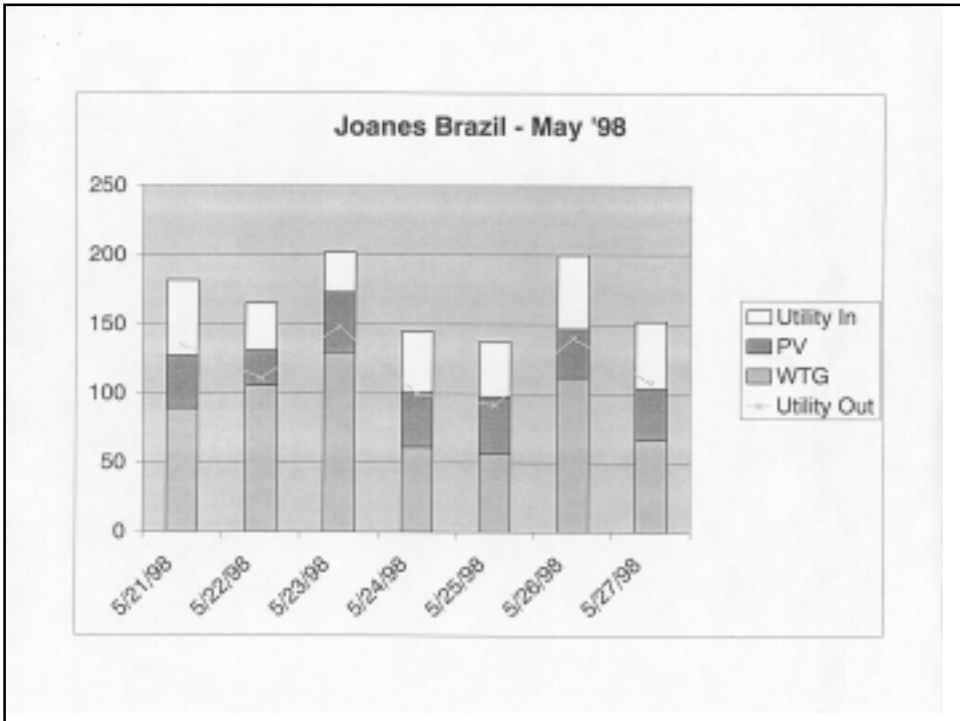

Northern
Energy
Systems

Hybrid Village Power System
Lime Village, Alaska

<u>Type of System</u>	50 kW; Stand-alone grid; PV/diesel, battery storage
<u>Application</u>	Village electrification; power previously available only from small individual generators
<u>Location</u>	Roadless interior, approx. 250 air miles from Anchorage
<u>Population</u>	45
<u>Peak Loads</u>	Undetermined
<u>Funding</u>	Alaska Science & Technology Foundation; Lime Village; Univ. of Alaska; State of Alaska
<u>Project Status</u>	Installed in 1998; waiting for generation permit; will be maintained by McGrath Light & Power; phone link provides remote access to operating data

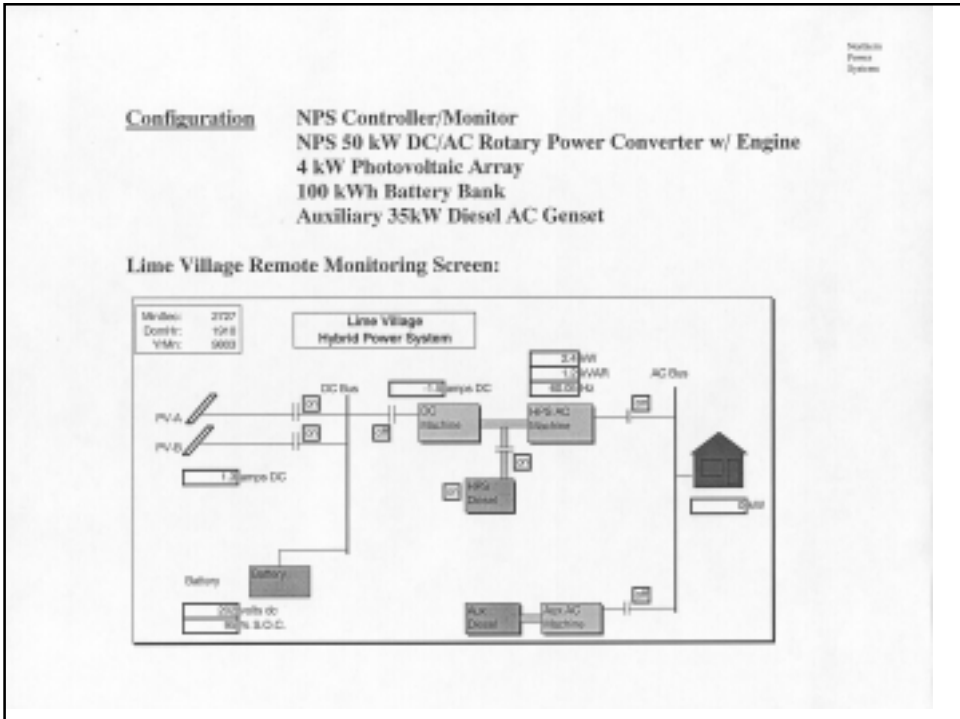
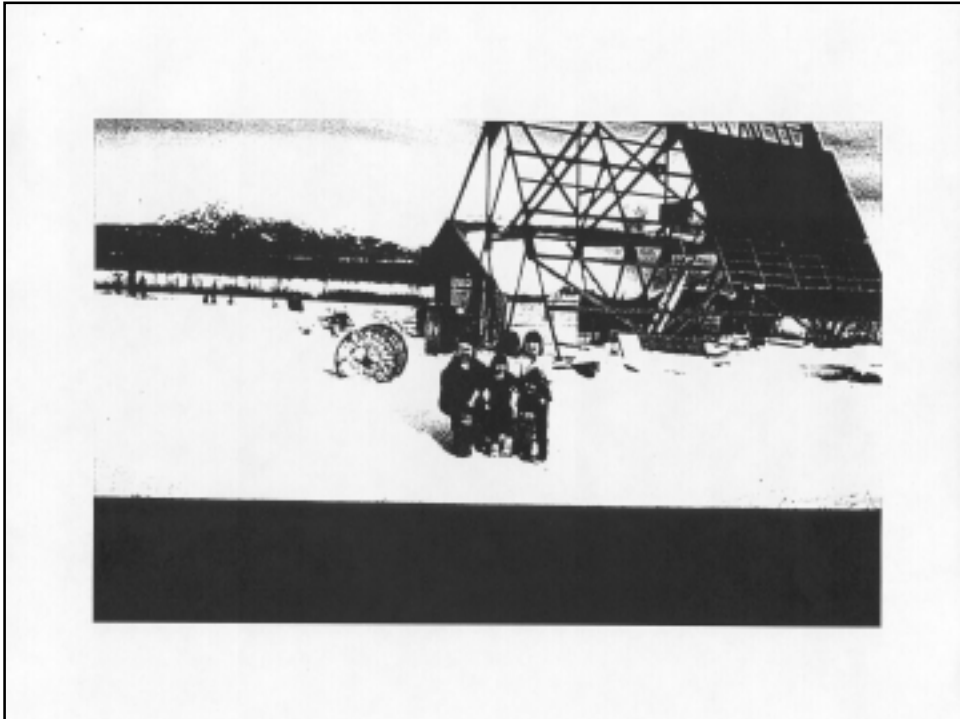

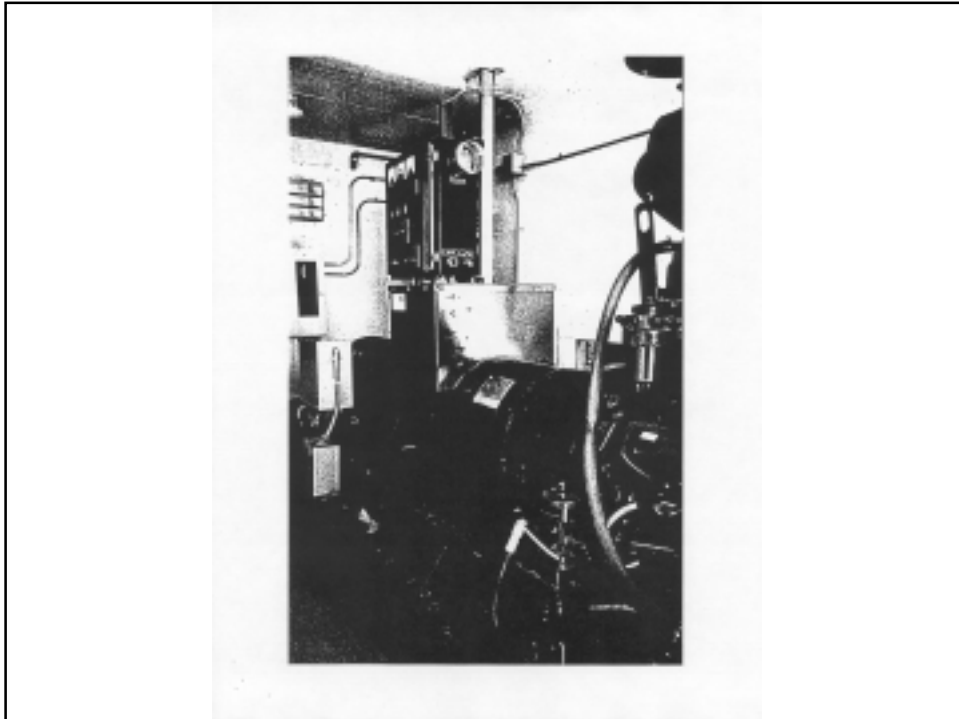

Hybrid
Power
Systems

Hybrid Village Power System St. Paul, Alaska

<u>Type of System</u>	300 kW; stand-alone; wind/diesel; heat storage
<u>Application</u>	High penetration wind/diesel system to provide electricity and space heat for village industrial facility
<u>Location</u>	Pribilof Islands in the Bering Sea
<u>Peak Loads</u>	160 kW
<u>Funding</u>	Tanadgusix Corporation (TDX)
<u>Project Status</u>	Equipment shipped from NPS for installation in late 1998; to be maintained by TDX; phone link provides remote access to operating data
<u>Cost of Energy</u>	± \$.20/kWh; current diesel grid cost is \$.32/ kWh

Configuration

NPS System Controller/Monitor
Vestas V-27 225 kW Wind Turbine
2 x Volvo 150 kW Diesel Gensets
HydroQuebec Dump Load Regulator

NPS Integrated Shelter/Container
NPS Heating & Thermal Storage
NPS Synchronous Condenser
Encorp Engine Controls

