



Wind Power

Windmill Electronics

Photo by Alan L. Pearlman

In Journal 1, we introduced the design of a home-built windgenerator made of recycled automobile parts, with details of the tower, swivel, transmission, and other mechanical parts. In the following article by Fred Archibald, we continue the development of the windmill by discussing the electrical system. The following diagrams and excellent technical advice allow the basic mechanical windmill to be adapted to several power ranges to suit the needs and situations of the builder. Equally valuable information is given concerning batteries and storage.

January 6, 1974

Dear New Alchemists:

I have been following your work with interest, and a little sense of participation, as I came up with the idea for the automotive differential-wheel spindle basis for a wind generator. Marc Sherman and I spent a long time discussing the system, both in the fall of '72 when the thing was started and this last Christmas. I have investigated the problem a bit further and hope that the following information, mainly on the electrics of the thing, will be of some use to you or your readers.

There are a number of problems associated with producing useful amounts of electric power from the wind for any length of time, if money is a consideration.

1. A constant voltage must be produced from a mechanical energy source (the propeller) varying from a few RPM to several hundred RPM.

2. A constant AC frequency of 60 CPS must also be produced from this variable speed source if standard appliances are to be used, and AC power frequency depends on AC generator speed.

3. The system must be able to withstand extremes of vibration, temperature, water and ice, corrosive salt spray and hundreds of thousands of revolutions with little maintenance.

4. It must be designed to extract as much energy from the wind as possible and transfer it efficiently to the utilities to be run.

5. As wind conditions, terrain, facilities, and power requirements will be different with nearly every installation, blade size and design, tower height, and the generator:propeller mechanical ratio will be more or less specific for the site.

6. The components must be fairly cheap, very rugged, and widely available.

Cutting corners on Nos. 3, 4 and 5 will make the whole project a great waste of effort. Really, if you don't have the time or facilities to do this thing right, it will only be a toy.

There are many possible generation systems, but the three thought most practical for a small home-type system are:

RESISTIVE UTILITIES
(INCANDESCENT LIGHTS
SMALL HEATERS)

110 VOLT
A.C. GENERATOR
(ALTERNATOR)

WIND
ENERGY

A

12 VOLT, 24 VOLT
DC UTILITIES

D.C.
STORAGE
BATTERIES

12 VOLT, 24 VOLT
DC. GENERATOR
(OR ALTERNATOR
w/ RECTIFIER)

WIND
ENERGY

B

VOLTAGE REGULATOR

115 VOLT AC.
UTILITIES

DC.-A.C.
INVERTER

D. C.
STORAGE
BATTERIES

12 VOLT DC
GENERATOR
(OR A.C. GENERATOR
WITH RECTIFIER)

WIND
ENERGY

C

12 VOLT DC.
UTILITIES

VOLTAGE REGULATOR

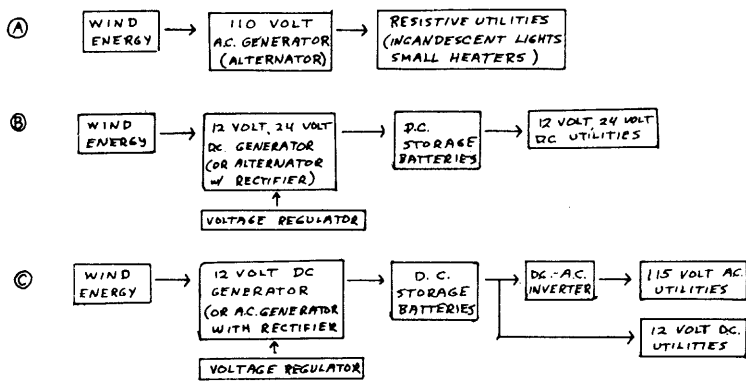

System (A) is the simplest, but an AC generator run off the wind will have widely varying frequency and voltage which would damage most appliances. Only resistive heaters and incandescent bulbs would be usable, and these would flicker on and off with the wind.

System (B) is the simplest system with storage capacity. A number of commercial wind systems use this. DC power is available at a regulated level, usually 12 or 24 V, even when the wind isn't blowing, and can be used for a wide variety of lights, motors, small heaters, and radios. Many of these things can be bought or scrounged from old cars (12 V) or ordered from automotive or marine supply houses. A small 12 V DC refrigerator is even made for marine use. However, the low voltage means high currents and therefore very heavy wire is needed. For instance, Edison calculated that it would take several *tons* of copper to light the houses in a city block using 10-volt bulbs in a 10-volt system. Therefore unless a great deal of heavy cable (like auto starter or 200 AMP arc-welder cable) is available, only small devices (< 50 watts) or ones very near the generator are feasible.

System (C), while the most complex, is the only one providing reliable power compatible with all the utilities in use commonly. The DC storage provides constant power whether the wind is blowing or not, and in turn allows the capture of wind energy when the electrical devices are not being used, which in a system without storage ability would go to waste. Both 12V DC and 115V AC utilities can be run directly and even European 230V AC ones with the simple addition of a transformer. The only limitations on this system are the *amount* of power produced daily, and the current or wattage rating of the inverter. Such a 115V AC system could be plugged directly into a house by pulling out the main circuit breaker or block of cartridge fuses and connecting the inverter directly to the house side of the circuit.

There are infinite variations on these three, depending on what's available, like 28V DC surplus aircraft generators, arc-welding generators, etc., but these are the basic alternatives open.

I won't discuss System (A), because it is the simplest to construct (electrically anyway) and is fairly useless except for heat production, and as even small heat-producing appliances like an iron or toaster use 750-1500 watts each, a very large generator and propeller would be needed to heat even a small building or fish pool.

The 115V AC system is just the 12V DC system with the inverters added, so it might be feasible to start with the 12 V system and later add the inverters. The solid state ones are around 70% efficient, i. e., 1000 watts of 12-volt DC power (83 AMPS) will produce 700 watts of 115V AC (about 6 AMPS).

The reliability needed in a fairly complex system like this is only possible with a really rugged well-designed generating system, and unless you have considerable engineering and technical facilities available to you, the best thing to do is adopt an entire system from another application. The only such system available and meeting the ruggedness, cheapness, and availability requirements is the modern automotive one. Only the automotive one is temperature-compensated to work from -40° to 260°F, go thousands of hours maintenance-free, and resist water, dirt, grease and exposure. If this doesn't sound like the generating system in your old car, it's because there have been some very significant improvements in the system since 1969, mainly the integrated circuit (IC) regulator.

These new systems employ an alternator (AC generator) with an internal rectifier bridge to produce DC and an IC regulator, often also within the alternator unit itself (on '72-'74 units). These alternators come in a number of power (wattage or amperage) ratings, and for the wind generator, the higher the better. Sixty AMPS is the largest common size on big American cars and the best for this application. Sixty AMPS at a nominal 12 volts is 720 watts. (generators actually put out 13-14 volts). This is the peak continuous output of 1 unit. As can be seen in the accompanying diagrams, 1, 2, 3 or 4 of these can be accommodated by the design, giving peak outputs of 720, 1440, 2160 and 2880 watts. In assessing the amount of power you need, it is very important *not* to compare directly the wattage ratings of the utilities to be used to these peak output values. The important figure is the *average* power output of the wind generator through 24 hours of the day. If optimal propeller and generator design will only produce 400 watts average (actually quite a good figure), then whether the peak potential power is 2160 or 2880 watts is not very significant, unless your area alternates between calm and very strong winds to get this average. To obtain a good average output, proper blade design, gear ratio, tower, and generator cut-in speed are all-important. The power capability of the system depends on the *length of time* used, at least as much as amperes consumed by

utilities, and the storage capacity of the batteries. Even the average power produced is wasted if there is not sufficient storage capacity to hold it and few utilities are being used. In other words, a system producing only 100 watts average output would have stored 2.4 kilowatt-hours a day, if the battery system is adequate, easily enough to run a stove once or twice a day. Actually this would take a large DC-AC inverter, and so such large heating jobs should better be left to DC or other energy sources. The principle, though, is important; a small, continuous power input to a good set of batteries will provide adequate power for high consumption occasionally, say for morning pumping, coffee percolating and evening lights, radio, etc. Perhaps it would make us more aware of electricity's value to us also.

The accompanying diagrams will explain the outline of a feasible electrical system for a wind generator. It doesn't include blade design (which I know very little about) or the over-all ratio between the blade speed and the alternator rotor speed. A high-speed 2-bladed propeller might have an over-all ratio of 8-10 revolutions of the rotor to one of the propeller, and a slower sail type or 3 or 4-bladed type perhaps 20-25:1 ratio. The ratio is determined by selecting an auto rear end with a proper ratio. They vary from about 2.7:1 in big cars with automatics to 4.6:1 for trucks and many small standard shift cars (Datsun, Toyota, British cars, etc.) On top of this, the ratio of the diameters of the pulleys on the pinion shaft and alternators is added; i. e., 2" alternator pulley to 10" pinion pulley. A wide selection of these aluminum pulleys can be found at any hardware store.

You'll probably read in the other papers about wind systems that pulleys, belts and gears all waste some of the wind's power. It's quite true, but the only way around it is to get a very slow-speed generator directly driven. It must have a very heavy shaft, heavy case and super bearings to take the propeller directly; and the only ones I know of are the ones custom-made for wind generators; and if you're willing to get into such expense, you might as well get an entire Quirk or Wincharger system. The auto rear end, of course, is a very long-lived and maintenance-free unit carrying a ton and with several-hundred horsepower flowing through it. So in a few-horsepower wind generator, it should last a tremendous length of time and consume relatively little power, if it is broken in and lighter oil is used.

Notes on Mechanical Aspects

- for best efficiency, remove original oil and put in 20 W motor oil and *new oil seals*
- spider gears in differential may have to be welded together ("spiked")
- tail axle tube must be welded shut

- assembly should be balanced on pivot (spindle)
- a wheel center can be conveniently bolted to the original studs and the steel or fiberglass of the blades affixed to it by welding, bonding or clamping
- a fiberglass or sheet-metal shroud should at least partially protect the alternators and pulleys (not shown)
- ideally a commutator would transfer power from the generator to the ground (to permit free turning of the generator with the wind). This would be very difficult to build as 12 volts would be impeded by even a slight resistance and the generator rendered ineffective. The cables are allowed to hang free with enough length for 2 or 3 revolutions. A steel cable slightly shorter than the power cables, firmly fastened to the base of the pole and the differential housing, would provide a "stop" and prevent the power cables from being ripped off.

- a heavy marine or military type plug in the power cables at the base of the pole will allow their being unwound if they become twisted around the pole.

- stays from the pole cap to the ground will give the whole unit more stability

- the bicycle generator can be of the common type that is spring-loaded against the tire, and in the same way pushes against the alternator belt. In case this is too fast, a suitable surface of rubber on the rim of the brake drum would provide a surface for the generator to run against. A section of an inner tube could be stretched around the outside of the drum like a large rubber band

- all welding should be arc, if possible
- bolts you expect to get loose again should be at least galvanized, preferably brass or stainless steel
- if the belts are kept tight and the pulley ratio not too tight, belt drive will work quite well with 1-2 generators. If 3 or 4 are to be used, a second pinion pulley and belt must be used. Also auto belt drive isn't good with larger generators (greater than 1 KW).

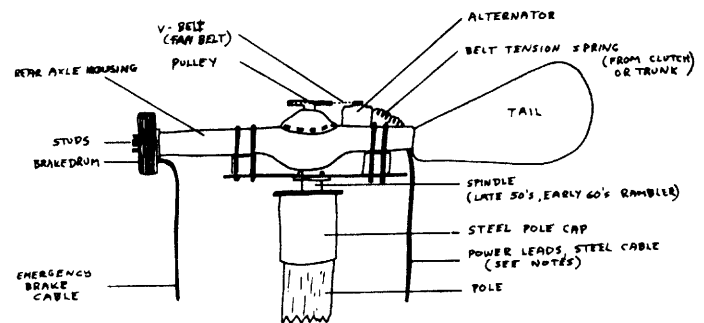

SIDE VIEW SINGLE ALTERNATOR UNIT

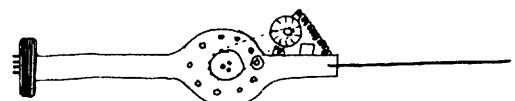

TOP VIEW SINGLE ALTERNATOR UNIT

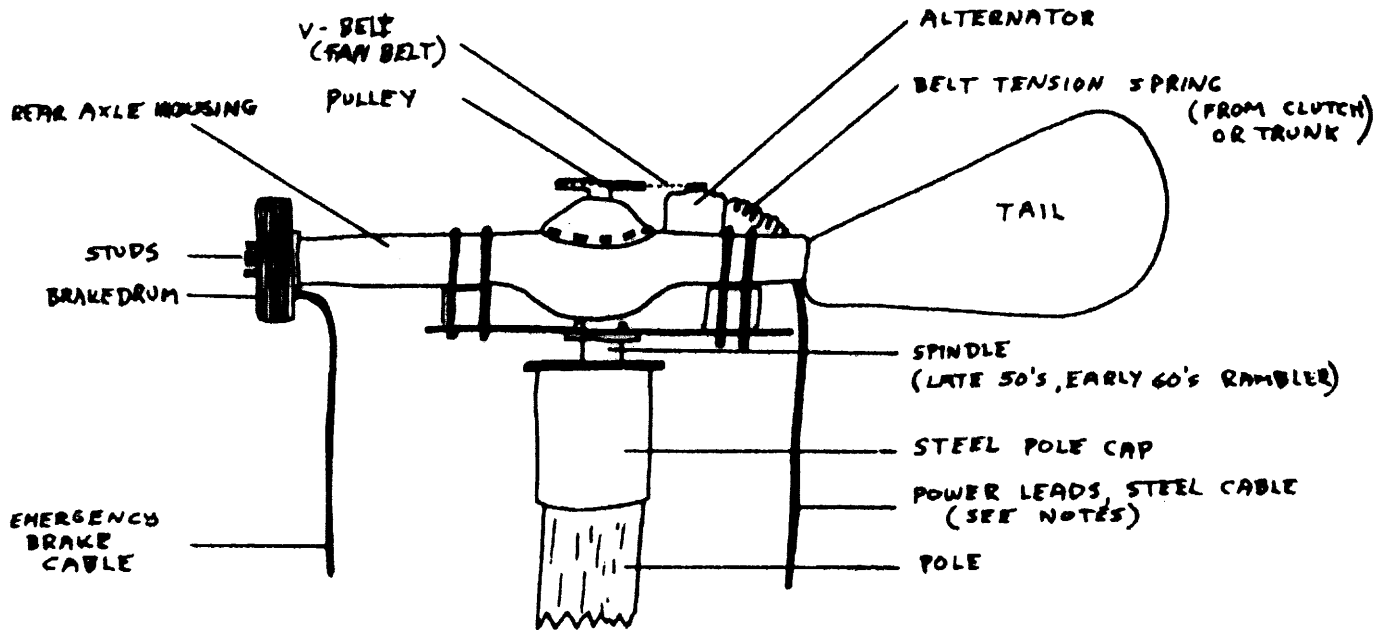

SIDE VIEW SINGLE ALTERNATOR UNIT

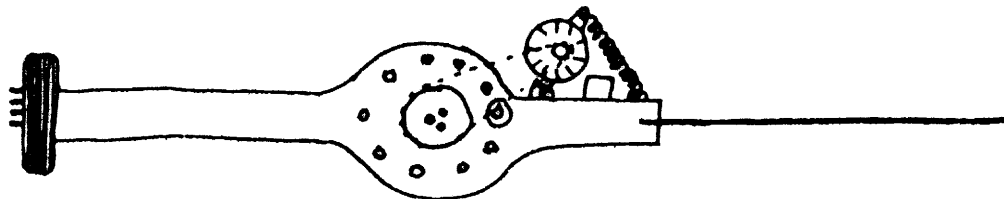

TOP VIEW SINGLE ALTERNATOR UNIT

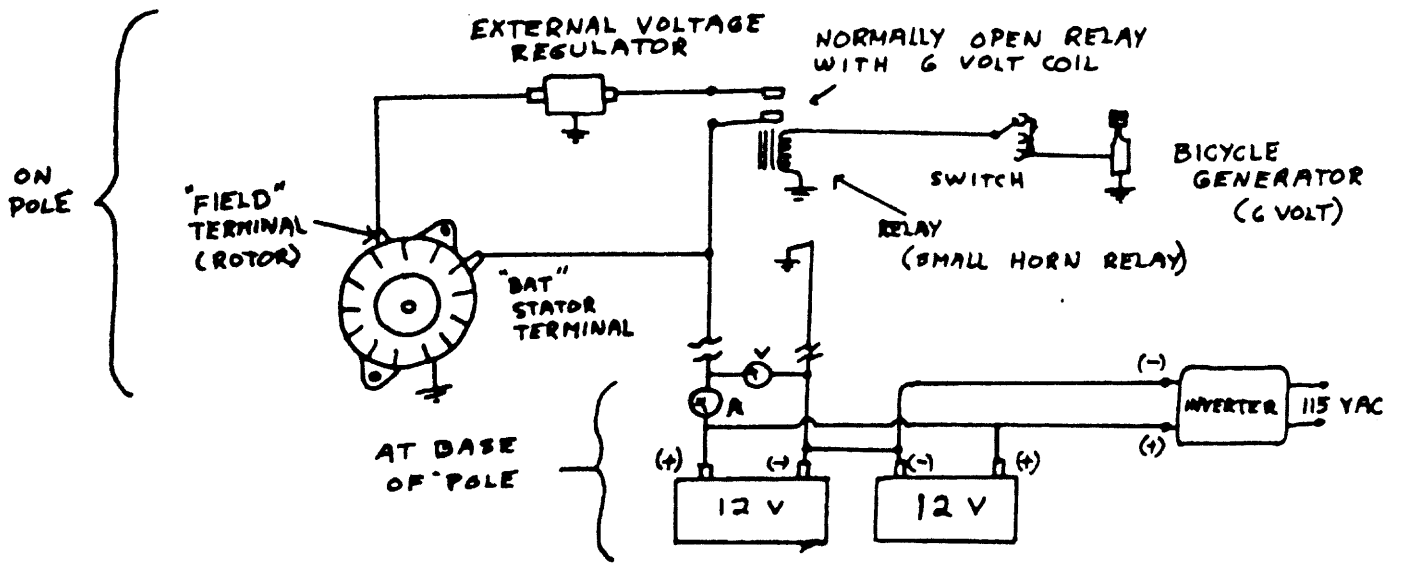

SINGLE ALTERNATOR SYSTEM

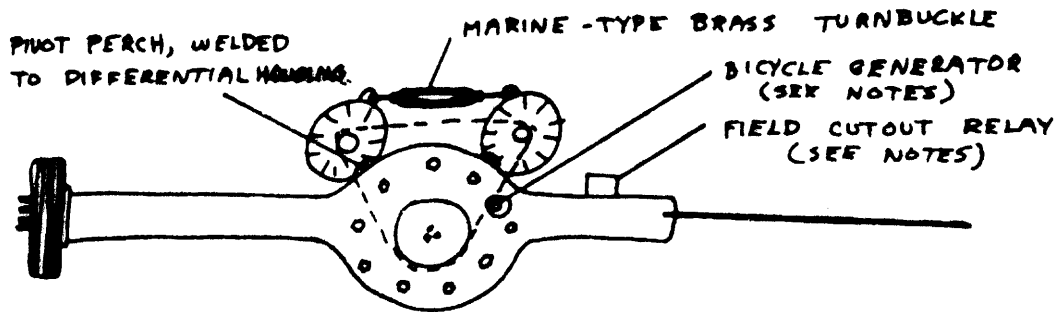

TOP VIEW 2 ALTERNATOR UNIT

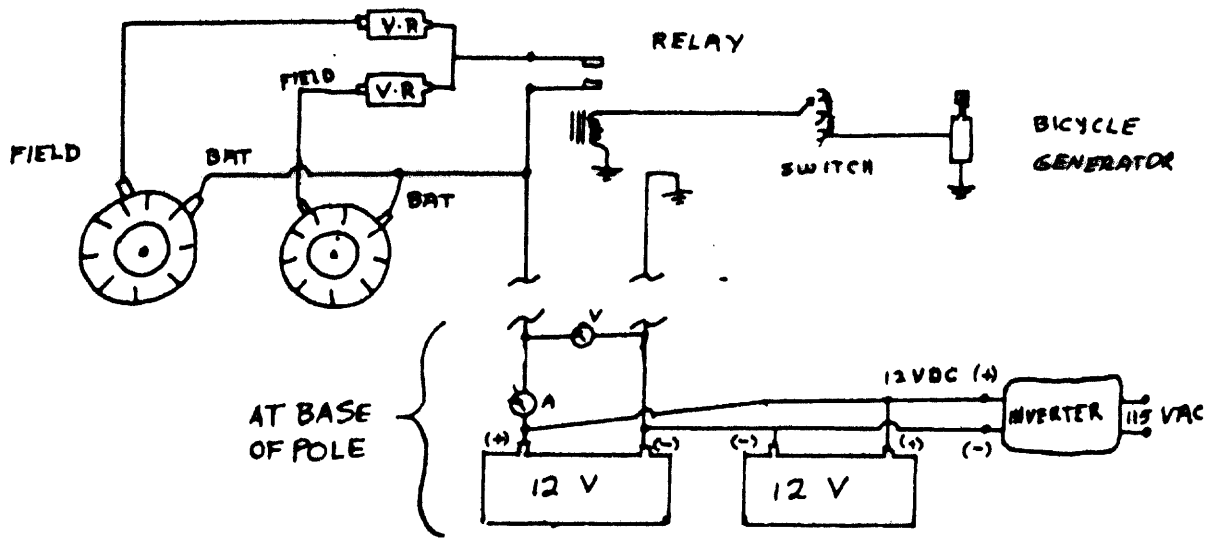

2 ALTERNATOR SYSTEM

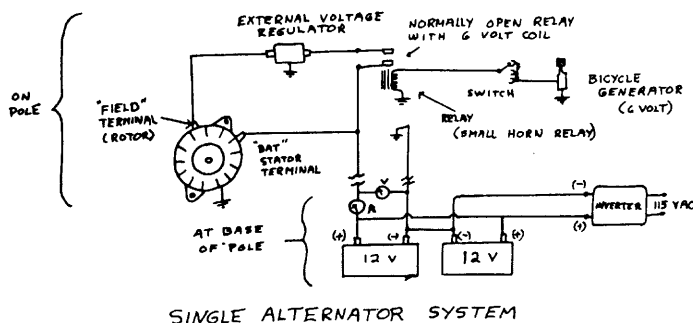

SINGLE ALTERNATOR SYSTEM

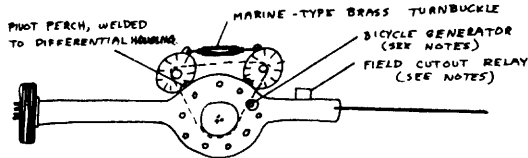

TOP VIEW 2 ALTERNATOR UNIT

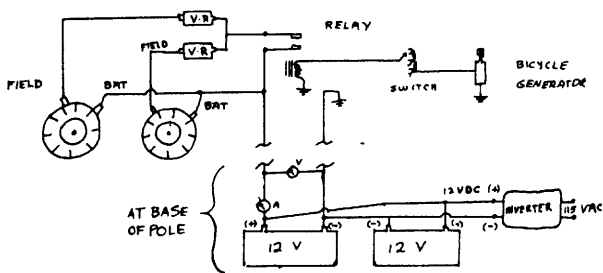

2 ALTERNATOR SYSTEM

Electrical Notes

- the bicycle generator-relay system cuts off the rotor current flowing from the (+) side of the battery when the speed of the wind is too low to produce power. In addition when the relay opens, the rotors free wheel, greatly reducing the drag on the propeller, allowing it to get up speed more easily. This is especially important in low-starting torque, high efficiency 2-bladed types.

- a 3-position switch is shown in the generator line. This will control the cut-in speed of the alternators. It may be desirable to change this according to the seasons or wind conditions. This could be replaced by a rheostat, or left out completely if desired.

- a good anemometer is a nearly indispensable aid in setting up and monitoring the machine, as is a \$15 "VOM" or electrical multimeter.

- the number of batteries needed will vary with the size of the system and how steadily the wind blows in your area, but remember that the batteries represent the only way to capture the wind's energy when utilities are off or using less power than is being generated. Therefore the more AMP-HOURS of battery capacity you have, the more efficient the system will be in using wind energy.

- the batteries will be one of the major expenses of the system so all the standard precautions should be taken to insure efficiency and long life.

1. Add only distilled water.
2. Keep them clean and dry.
3. Check them with a hydrometer frequently (1.230-1.280 corrected for temperature)
4. Have heavy wires and good connectors (covered with grease to prevent corrosion).
5. Don't completely discharge them, especially in winter.

- an integral alternator-regulator unit is wired just as units with a separate regulator (see sketches and schematics) with the low speed cutout relay taking the place of the ignition switch.

- these wires grounded securely to differential housing

- the more batteries are paralleled, the more wind energy you can store and the more will be available for peak use periods.

- the 2 alternator is almost identical to the single. Three or four can be paralleled in the same way. Make sure the relay has adequate capacity (current handling ability) if several units are used.

- all wires should be *soldered*, not clipped, clamped or screwed on the wind generator unit and the joints protected with acrylic, silicone or some other protective material.

- field and bicycle generator leads can be 16 or 18 gauge copper insulated, but (+) and (-) power leads from the stators to the batteries and inverter *must* be very heavy copper like arc-welding or auto "jumper" cables or most of the power generated will be used up in heating the power leads, and the voltage regulator won't work properly.

- wires on the wind generator should be tied down to prevent flexing in the wind .

- the external voltage regulator (if present) and cut-out relay should be sealed as well as possible against the weather.

- be sure all electrical units (alternators, bike generator, relay, voltage regulator) are well grounded to the differential housing. Small pieces of braided grounding strap brazed to the housing are good.

- once installed, the solid state rectifiers (in the alternator) and voltage regulator are rugged and reliable, but if their polarity or battery polarity is reversed (the battery is hooked up backwards), they can be permanently damaged in a few seconds.

- the 1969 and later alternators with "IC" regulators are by far the best ones to get, but in any case it's probably not worth using the older DC generators (pre-1960 approximately) as they have much less power output and more maintenance, wiring, and poorer regulation and reliability.

- a spark-gap (1/4" or so, obtainable as a TV-antenna accessory, or home-made) should be put between the (+) cable at the base of the pole, and the (-) terminal grounded by a steel stake, to protect against lightning. Unless you really need the power, it's probably best to

disconnect the batteries and inverter during thunder and lightning storms.

- at least a DC volt meter and ammeter to monitor generator output should be mounted in the battery box, and preferably an AC ammeter and volt meter in the house, barn, etc., to monitor inverter output.

- never completely discharge the batteries as this shortens their life.

- lock the blade with the emergency brake whenever disconnecting the power leads between the batteries and the alternators. To disconnect the alternator from the batteries while it is charging could damage it.

- the excellent regulation provided by the IC regulator should significantly increase battery life.

- an alternator has brushes, but the slip ring has no breaks like the generator's commutator, eliminating nearly all the wear and sparking. Also an alternator's brushes only carry the field (rotor) current (1-3 AMPS) while a generator's must carry the full output (20-40 AMPS). Therefore alternator brushes generally last many times the life of generator brushes.

- if you stick to 12 V DC power, remember that every auto has two very useful large motors, the starter and the generator (the DC type, not an alternator). The starter is a series-type motor, with tremendous starting torque, good for low speed, heavy jobs, but takes lots of power and the generator is a shunt-type motor. This is really a versatile unit that can produce up to about 1/3 horsepower at a variety of speeds and can be picked up in any junkyard from 1955-1963 American cars. These units can be rewired or rewound if you are really a do-it-yourself type, but can be used directly and the speed controlled by a rheostat between the fields and the armature (about 10-15 ohms at 25 watts).

- actually if you wanted only a small amount of AC, one of these units driving an alternator from a later car with the diodes bypassed for AC and the DC motor (generator) adjusted to the right speed with the field rheostat to the proper speed will produce 115V AC at 60 cycles at a fraction of the cost of an inverter.

- for a really cheap auxiliary power supply, in case the wind doesn't blow, a 2½-3 horsepower horizontal crankshaft lawnmower engine will run an auto alternator, which can produce 12 V to charge the batteries

or 115V AC 60 CPS if the engine speed is adjusted properly, usually 1800 or 3600 RPM.

- actually, in obtaining old alternators and generators, I stopped at a number of service stations and asked to look through their trash and got more old units than I knew what to do with for nothing, and most of them, after cleaning, were either perfectly usable or needed only a bearing, diode, or set of brushes!

- Chrysler specifies regulation (charging) of their IC-alternator from 50-5000 RPM; Ford and GM, I couldn't find.

Costs

- it's impossible to give a figure, as this depends on scrounging, but quality parts in some areas are a must.

- look at the ampere-hour capacity of batteries. A \$35 battery often has twice the capacity of a \$25 one as well as better materials and construction.

- rebuilt alternators (\$25-\$60) are usually just as good as new ones, if they come from a reputable firm and much cheaper. J. C. Whitney Co. of Chicago, a mail-order auto-parts firm, has good prices on these items. If you're handy, junkyard ones can be renovated for even less.

- the inverter(s) are another major cost, and as the solid state "multivibrator" type are quite new, there isn't much chance of finding a used one. The older mechanical reed type is rarely found, and anyway is very inefficient. A 500 watt continuous, 550 watt intermittent unit costs about \$110 from such places as Lafayette Radio or J. C. Whitney. If more power is needed, two or more units can be bought. It's possible to make one from parts, if you are handy, but considering the time and effort and the cost of the parts, it's not practical unless you can "scrounge" the parts.

I guess all this makes pretty dull reading, but for the person serious about such a project, I hope it is of some use. Good luck in your various ventures!

— *Frederick Archibald
Biology Department
Dalhousie University
Halifax, Nova Scotia, Canada*

* * * * *

POSTSCRIPT

The last major hurdle of a low-cost wind generator is the blade technology and construction. Currently the only dependable blade design is a high-speed airfoil blade made of wood or fiberglass. This type of blade can be handmade, but becomes more difficult in larger sizes. We are presently investigating nautical

sail design to determine if the long tradition and recent advances in that art can be turned toward low-cost wind generators. Progress toward that end is the success of the self-regulating sail-blades of Marc Sherman's water-pumping windmill described in this Journal.